

# F Series

## BULKHEAD MOUNT. SOLDER POT TERMINAL

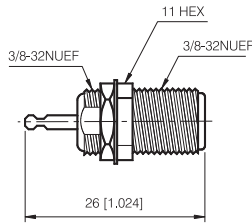
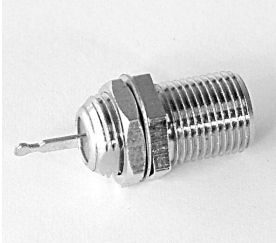

### BULKHEAD JACK RECEPTACLE-FRONT MOUNT

P/N	Cable Group	Impedance
114-F510	N/A	75

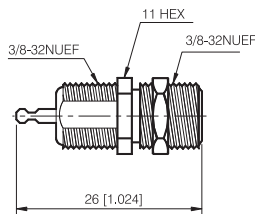
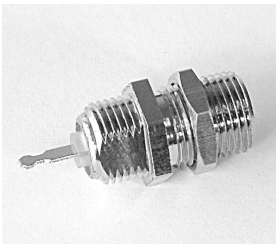

### BULKHEAD JACK RECEPTACLE

P/N	Cable Group	Impedance
114-F520	N/A	75

# F Series

## BULKHEAD MOUNT. SOLDER POT TERMINAL

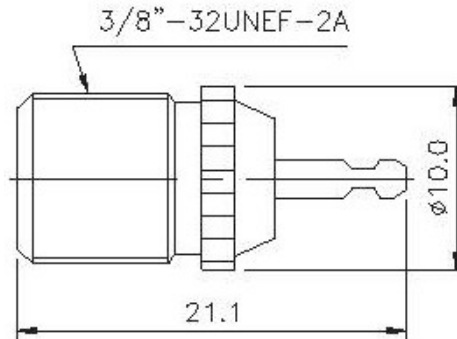

JACK BULKHEAD		
P/N	Cable Group	Impedance
114-F530	N/A	75

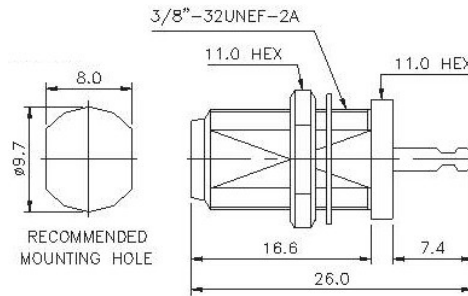

JACK BULKHEAD		
P/N	Cable Group	Impedance
114-F540	N/A	75

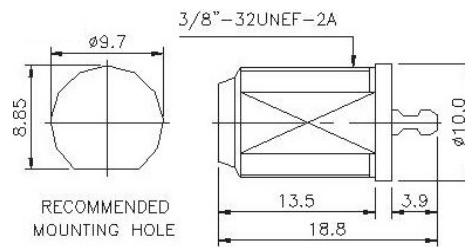

JACK BULKHEAD		
P/N	Cable Group	Impedance
114-F550	N/A	75

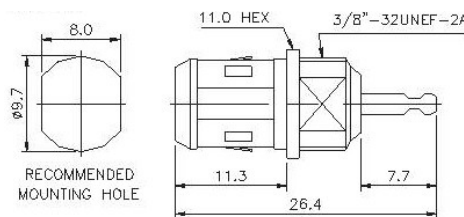

JACK CONNECTOR		
P/N	Cable Group	Impedance
114-F560	N/A	75