

UHF Series

OTHERS

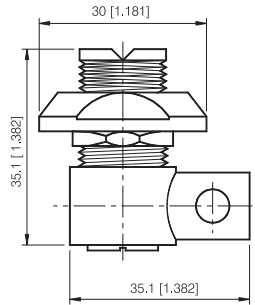

RIGHT ANGLE JACK(1,SD,3D,SD,8D,10D)

P/N	Cable Group	Impedance
105-F910	N/A	N/A

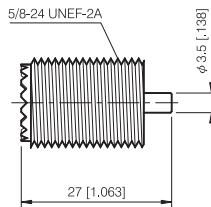
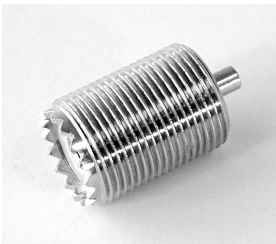

BULKHEAD JACK

P/N	Cable Group	Impedance
105-F930	N/A	N/A

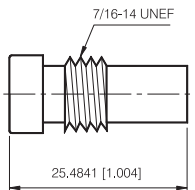

REDUCING ADAPTOR

P/N	Cable Group	Impedance
105-F940	01	50
105-F941	05	50

UHF Series

OTHERS

UHF

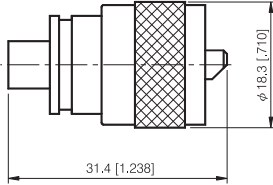

UHF PLUG, MOLDER TYPE

P/N	Cable Group	Impedance
105-M910	N/A	N/A

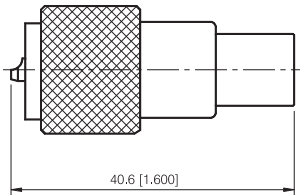

TWIST-ON PLUG

P/N	Cable Group	Impedance
105-M970	01	50
105-M971	05	50

UHF Series

OTHERS

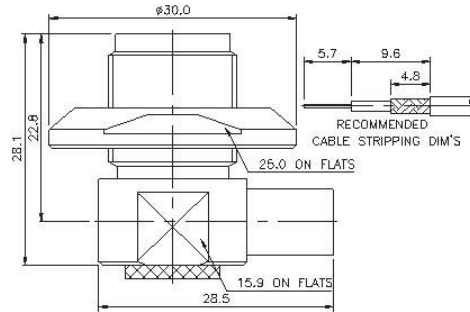

RIGHT ANGLE UHF PLUG TWIST ON

P/N	Cable Group	Impedance
105-F972	01	50
	13	50